



Please visit [www.acorneng.com](http://www.acorneng.com)  
for most current specifications.

# Terrazzo-Ware™ Mop Sinks



**TECHNICAL ASSISTANCE TOLL FREE TELEPHONE NUMBER:  
1.800.591.9360**

Technical Assistance E-mail: [FieldService@acorneng.com](mailto:FieldService@acorneng.com)

**Please refer to the Link or QR code provided.**

For Cleaning & Care Guide:

<https://www.acorneng.com/uploads/fileLibrary/9900-008-001.pdf>



Drawing #: 3030-738-000 A 4/21/23

**ACORN ENGINEERING COMPANY**  
P.O. BOX 3527 • CITY OF INDUSTRY, CA 91744 U.S.A.  
TOLL FREE 800-488-8999 :: LOCAL 626-336-4561  
FAX 626-961-2200 :: [www.acorneng.com](http://www.acorneng.com)

**ACORN ENGINEERING COMPANY**

**ACORN ENGINEERING FIELD SERVICE**  
TOLL FREE 800-743-8259 • LOCAL 626-855-4866 • FAX 626-855-4863



### 1 HANDLING

Carefully remove **Mop Sink** from carton at installation point. Avoid placing **Mop Sink** on its edge. (This precaution will prevent damage to corners of **Mop Sink**.)

#### METHOD FOR CHECKING FACE OF **Mop Sink** FOR TRANSPORTATION DAMAGE:

- A. Wipe face of **Mop Sink** with a wet cloth (Water).
- B. When the water evaporates, any slight crack in the **Mop Sink** will be noticeable.

### REMOVE MOP SINK CAREFULLY FROM CARTON

REMOVE PACKAGING WITH CARE

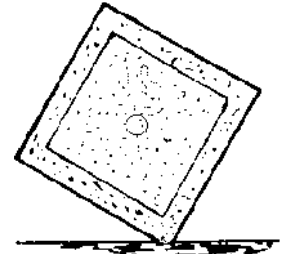
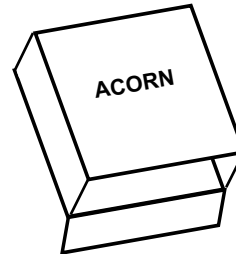

AVOID STANDING MOP SINK ON END

### 2 LEVELING

Level **Mop Sink** carefully. For proper installation, establish a 1/4" clearance between **Mop Sink** and the walls. A layer of mortar or sand must be placed in area where the **Mop Sink** is to be installed. This procedure is recommended in order to support **Mop Sink** should the sub floor be uneven. Grout should be exposed along edges.

*NOTE:* Mortar or sand must cover the entire area between **Mop Sink** and building floor.

*\*NOTE:* Inspect and test for proper drainage.

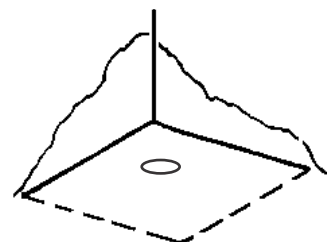
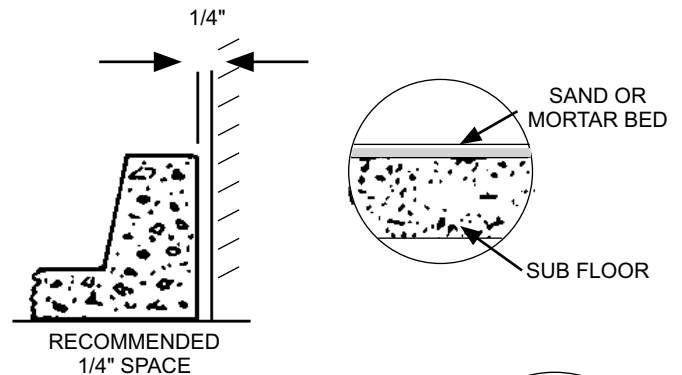

DOTTED AREA IS FOR MOP SINK

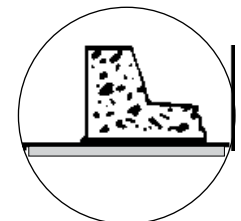

GROUT EXPOSED SIDES

### 3 WARNING!

**DO NOT DROP MOP SINK OVER EXPOSED PIPE.**

It is advisable to remove drain pipe and set **Mop Sink** in place. Insert pipe through drain in **Mop Sink** back into "P" trap. Tighten with an internal pipe wrench.

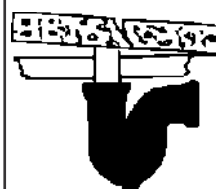

DO NOT DROP ON PIPE

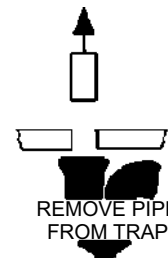

REMOVE PIPE FROM TRAP

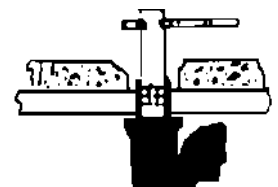

REINSERT PIPE AND TIGHTEN WITH AN INTERNAL WRENCH



## TERRAZZO-WARE™ MOP SINKS

### IMPORTANT

Connection of Drain is made completed using Optional KDG3 - 3" Neoprene Flexible Drain Gasket for 3" IPS waste pipe. Provides quick connection with inside caulk waste outlet on shower base to 3" drain DWV plastic, Sch. 40, steel or X.H. (extra-heavy) cast iron pipe. Requires no special tools gluing, threading or lead caulking. (Similar Industry Standard Drain Gasket products are available off the shelf.)



### 4 RECOMMENDED PROCEDURE.

#### INSTALLATION INSTRUCTIONS:

1. Cut drain pipe to extend 1-3/8" into drain body. Drain pipe should be even with top of gasket when installation is completed. Position **Mop Sink** over 3" waste pipe making sure that pipe is centered in drain body.
2. Lubricate gasket with soap solution and stretch over 3" pipe with letters facing up.
3. Push gasket as far as possible into joint.
4. Using a hammer and caulking tool or 1/4" X 3/4" X 6" piece of wood instead of a caulking tool, work around the gasket with a series of blows and gradually drive gasket into drain body until it bottoms. Drain pipe should be even with the top of gasket.
5. Test connection before covering or concealing. To test: plug 3" drain and fill receptor with water. Check for leaks. Verify proper drainage. **This must be done before finishing walls.**

#### NOTE:

As an alternate, drain connection made be using Lead and Oakum installed per Industry Standards of best Practice. Verify local code requirements.

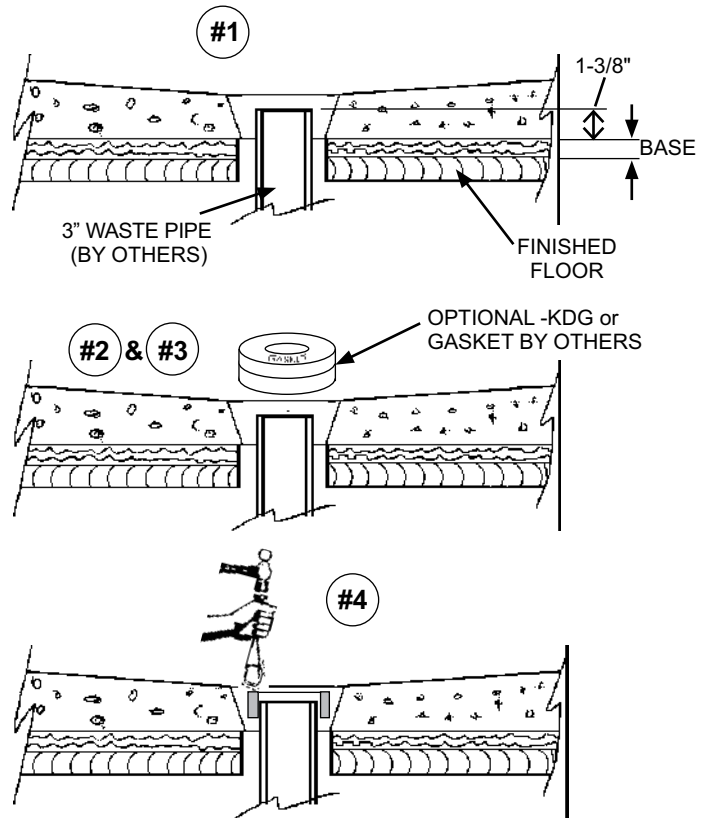

### 5 WARNING!

#### MODELS WITH -TF TILING FLANGE OPTIONS:

- A. Do not let rough wall Material Overlap Flange.
- B. Do not attach flange to building wall.
- C. Let finished wall (tile, etc.) overlap and rest on shoulder.

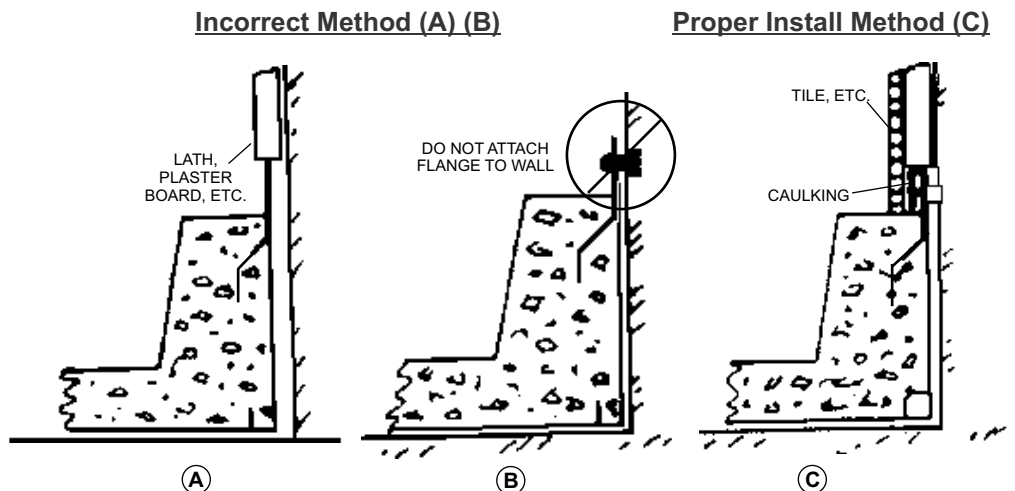



TERRAZZO-WARE™ MOP SINKS

**-KF TILING FLANGE OPTION DETAIL:**

**Important:** When Specified, (-TF) Tiling Flanges are cast into Terrazzo Shower and Mop Bases at the time of production making them integral with the unit to provide the best possible Water-Resistant Seal. The (-KF) Tiling Flanges are offered to assist installers when units are not provided with integral Tiling Flanges. This detail is provided for reference (only) to assist installer with recommended placement for attachment. Installer is responsible for installing Terrazzo Bases using Industry Standards of practice best suited for site conditions to mitigate the potential for water leakage around the fixture. Acorn Engineering Company is not responsible for damage to fixtures or equipment as a result of work performed by others.

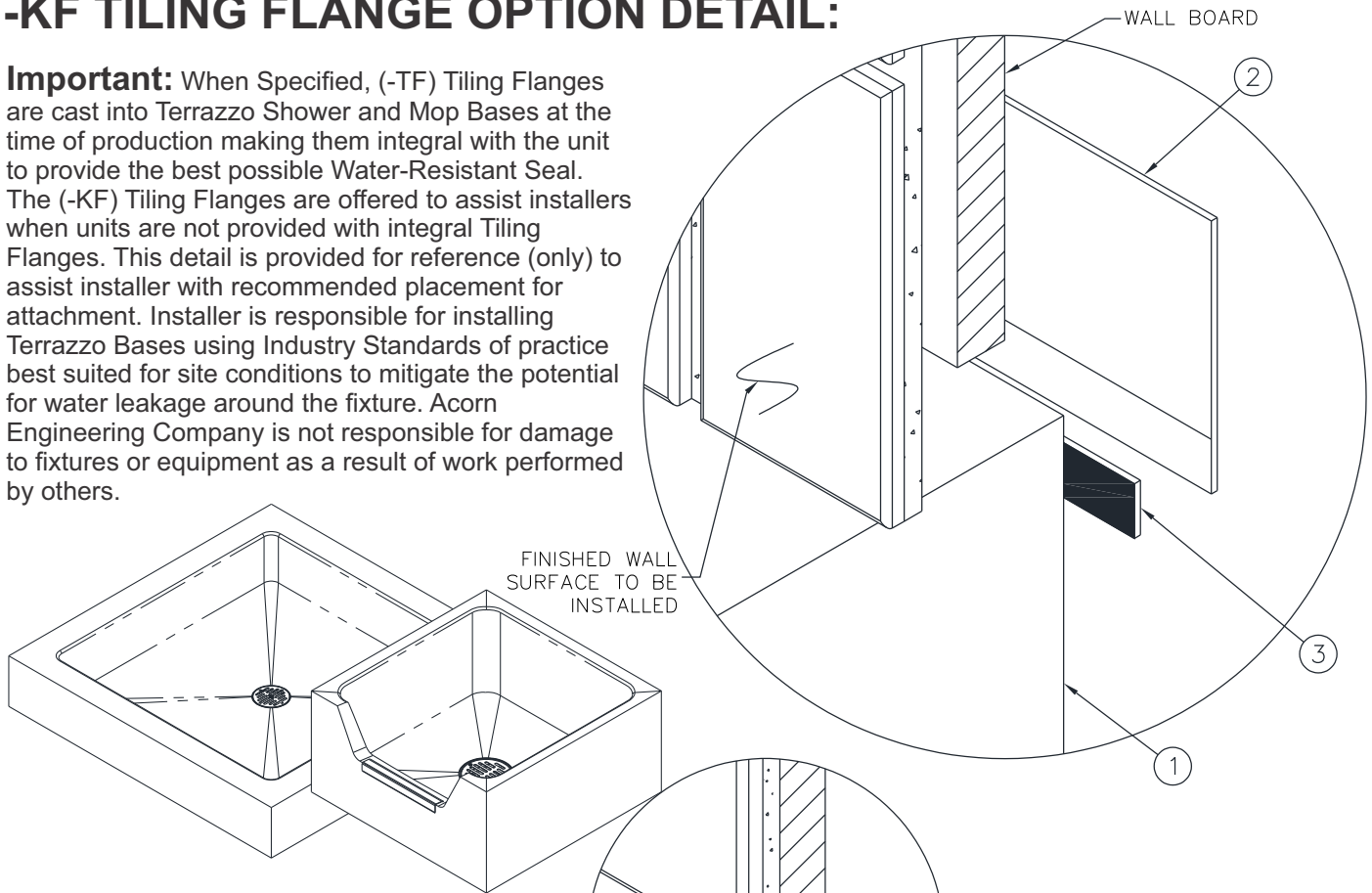

**Recommendations:**

- A. Clean shoulder surface area on Terrazzo Fixture [1] and KF Tiling Flange [2] with a quality dish soap to remove any film, oil, grease, or other substance left over from manufacturing.
- B. Pull off backing strip on double sided Foam Tape [3] and adhere to bottom edge of KF Tiling Flange [2].
- C. Remove remaining backing strip on double sided tape [3] and fix KF Tiling Flange to Fixture [1], ensuring that approximately 1" of KF Tiling Flange [2] minimum extends above shoulder of shower base.
- D. Fill remaining gap between KF Tiling Flange [2] and Terrazzo Fixture Shoulder [1] with a waterproof adhesive such as Rtv Silicone.
- E. Install fixture per installation instructions for your Terrazzo Shower Base / Mop Sink.

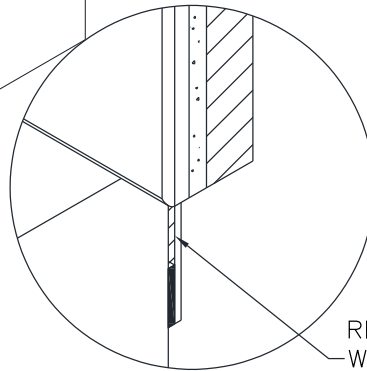

RECOMMENDED: FILL GAP WITH WATERPROOF ADHESIVE PRIOR TO APPLYING WALL FINISH

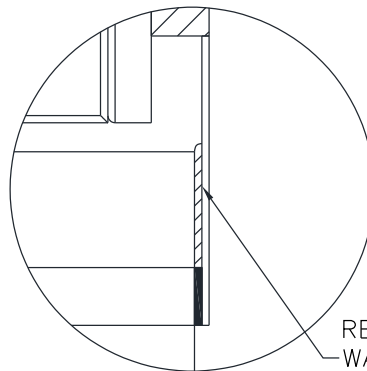

RECOMMENDED: FILL GAP WITH WATERPROOF ADHESIVE PRIOR TO APPLYING WALL FINISH